

# Danfoss Aluminum Gear Pumps G0-G1

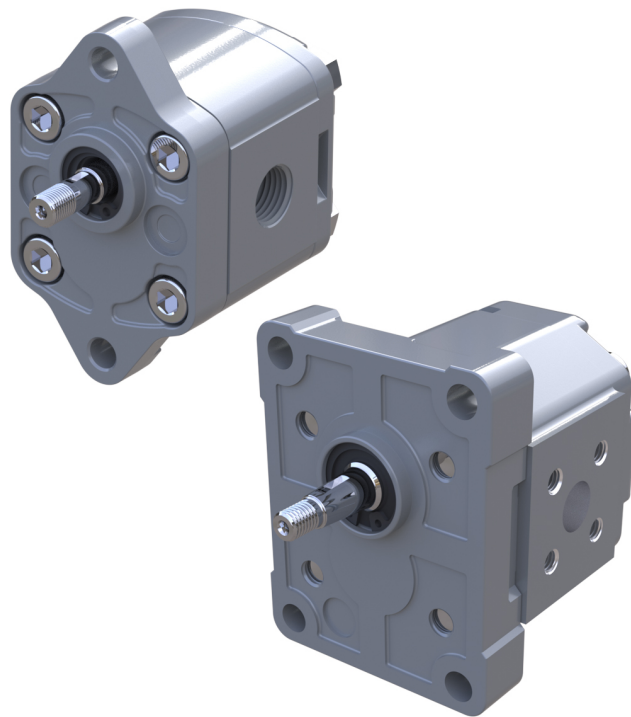

**Contents**

**General Information**

Overview.....5  
 Features and benefits.....6

**Group 0**

Design.....7  
 Features.....7  
 Product Code.....8  
   Model code.....8  
     A Family.....8  
     B Displacement.....8  
     C Rotation.....9  
     D Project version.....9  
     E Mounting flange.....9  
     F Drive gear.....9  
     G Rear cover.....9  
     H Inlet size; I Outlet size.....9  
     J Ports positions & Special body.....10  
     K Seals.....10  
     L Screws.....10  
     M Set valve.....10  
     N Type mark.....10  
     O Mark position.....10  
 Dimensions.....11  
   TFPONN-01FA.....11

**Group 1**

Pump design.....12  
 SNP1NN.....12  
 SKP1NN.....13  
 SKP1IN.....13  
 Pump displacements.....14

**General Information**

Technical data.....15

**Product Code**

Model code.....17  
   A Family.....17  
   B Displacement.....17  
   C Rotation.....17  
   D Project version.....17  
   E Mounting flange.....18  
   F Drive gear.....18  
   G Rear cover.....18  
   H Inlet size; I Outlet size.....18  
   J Ports positions & Special body.....19  
   K Seals.....19  
   L Screws.....20  
   M Set valve.....20  
   N Type mark.....20  
   O Mark position.....20

**Determination of Nominal Pump Sizes**

Determination of nominal pump sizes.....21

**System Requirements**

Pressure.....22  
 Speed.....22  
 Hydraulic fluids.....23  
 Temperature and viscosity.....23  
 Filtration.....24

**Contents**

Filters.....	24
Selecting a filter.....	24
Reservoir.....	24
Line sizing.....	25
Pump drive.....	25
Pump drive data form.....	26
Pump Life.....	27
Sound levels.....	27

**Pump Performance**

Pump performance graphs.....	28
------------------------------	----

**Product Options**

Flange, shaft and port configurations.....	31
Shaft options.....	32
Inlet/Outlet port configurations.....	33
Ports.....	33
SNP1IN.....	34
Variant codes for ordering integral relief valves.....	35
Integral relief valve schematic.....	37

**Dimensions**

SNP1NN - 01BA and 01DA.....	38
SKP1NN – 02BB and 02FA.....	39
SNP1NN – 03CA.....	40
SKP1NN – 06GA and 06SA.....	41

**General Information****Overview**

The Danfoss Group 0 and Group 1 is a range of peak performance fixed-displacement gear pumps. Constructed of a high strength extruded aluminum body with aluminum cover and flange, all pumps are pressure-balanced for exceptional efficiency. The flexibility of the range, combined with high efficiency and low noise, makes the pumps in this series ideal for a wide range of applications, including: turf care, aerial lifts, material handling, and power packs.

*TFP0NN 01FA*



*SNP1NN 01BA*

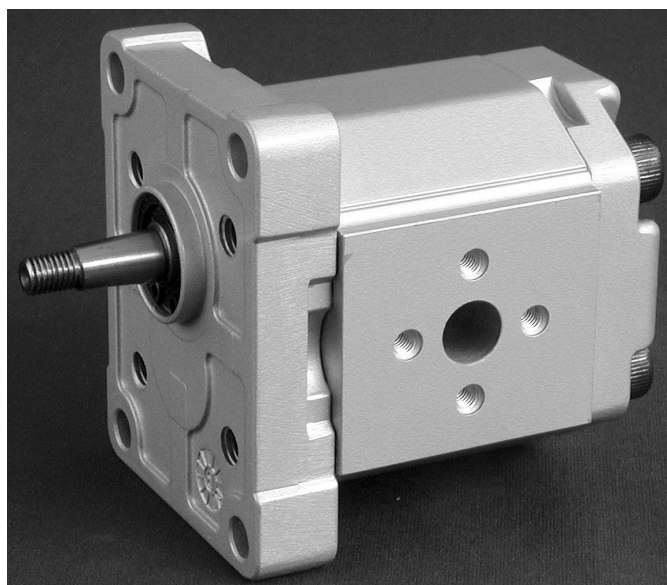

## General Information

SKP1NN 06SA

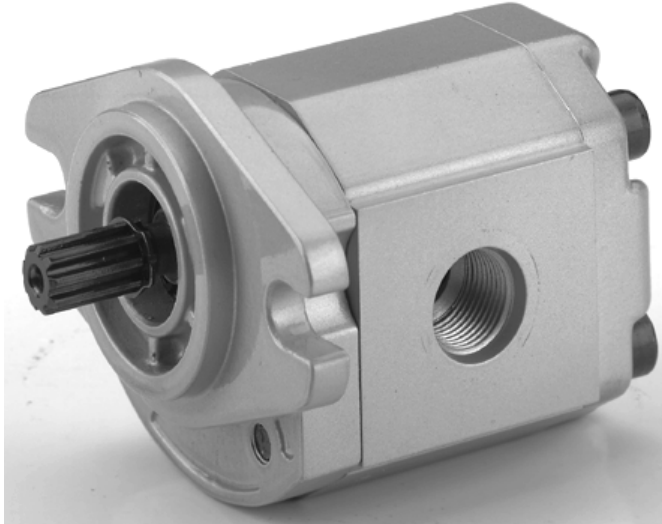

SNP1NN 03CA

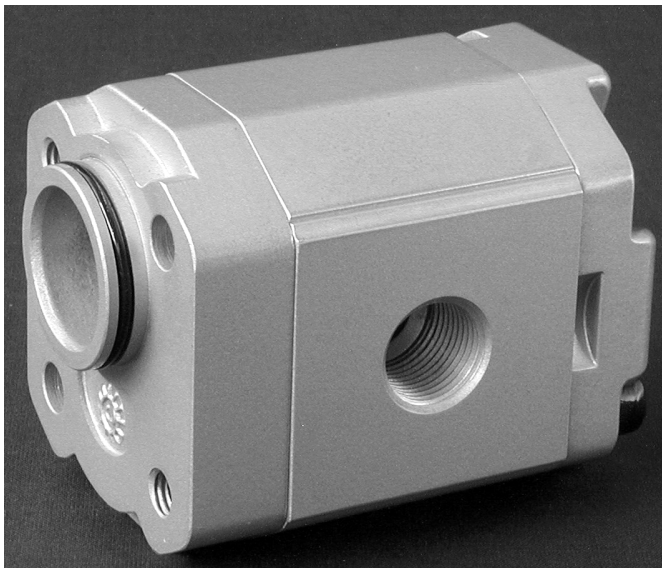

## Features and benefits

### Gear pump attributes:

- Up to 16 displacements from 0,25 to 12 cm<sup>3</sup>/rev [from 0.015 to 0.732 in<sup>3</sup>/rev]
- Continuous pressure rating up to 250 bar [3625 psi]
- Speeds up to 4000 min<sup>-1</sup> (rpm)
- SAE, ISO, and DIN mounting flanges and shafts
- Compact, lightweight, quiet operation
- Group 1 units are available as unidirectional and bi-directional motors, also with integral relief valve
- You can combine groups 1, 2 and 3 to make multi-stage pump

**Group 0**

OwerTFP0NN pumps provide flexibility, numerous displacements, features, and shaft/port options. The TFP0NN series has earned an excellent reputation for rugged, dependable performance at continuous pressures and speeds.

*TFP0NN 01FA*



TFP0NN pumps are available in five displacements from 0.25 to 1.27 cm<sup>3</sup>/rev [0.015 to 0.075 in<sup>3</sup>/rev]. Complete information can be found by referring to the specific sections in this technical manual.

**Design**

Constructed of high strength aluminum, the TFP0NN rotation is either clockwise or counterclockwise.

**Features**

Special features of Group 0 pumps include:

- Wide range of displacements
- Parallel shaft ends
- Standard mounting flange (European, 2-bolt)
- European port options

**Group 0**

*Technical data – Group 0 gear pumps*

		Frame size				
		,25	,45	,57	,76	1,3
<b>Displacement</b>	cm <sup>3</sup> /rev [in <sup>3</sup> /rev]	0.25 [0.015]	0.45 [0.027]	0.57 [0.034]	0.76 [0.045]	1.27 [0.075]
<b>Peak pressure</b>	bar [psi]	200 [2900]	200 [2900]	200 [2900]	200 [2900]	200 [2900]
<b>Rated pressure</b>		180 [2600]	180 [2600]	180 [2600]	180 [2600]	180 [2600]
<b>Minimum pressure at maximum speed</b>		103 [1500]	103 [1500]	103 [1500]	103 [1500]	103 [1500]
<b>Minimum speed at 103 bar [1500 psi]</b>	min <sup>-1</sup> (rpm)	500	500	500	500	500
<b>Maximum speed</b>		8000	8000	8000	7000	5000
<b>Weight</b>	kg [lb]	0.40 [0.88]	0.45 [1.00]	0.46 [1.01]	0.47 [1.03]	0.48 [1.06]
<b>Moment of inertia of rotating components</b>	x 10 <sup>-6</sup> kg·m <sup>2</sup> [x 10 <sup>-6</sup> lb·ft <sup>2</sup> ]	0.425 [10.09]	0.544 [12.91]	0.621 [14.74]	0.737 [17.49]	1.049 [24.89]
<b>Theoretical flow at maximum speed</b>	l/min [US gal/min]	2.00 [0.53]	3.60 [0.95]	4.56 [1.20]	5.32 [1.41]	6.35 [1.68]

1 kg·m<sup>2</sup> = 23.68 lb·ft<sup>2</sup>

[For applications requiring parameters beyond those listed above, contact Danfoss.](#)

**Product Code**

**Model code**

**A Family**

A	B	C	D	E	F	G	H	I	J	K	L	M	N	O
• • • • • /														

<b>TFP0NN</b>	Std gear pump
<b>TFR0NN</b>	Reversible pump

**B Displacement**

A	B	C	D	E	F	G	H	I	J	K	L	M	N	O
/ • • •														

<b>0,25</b>	Displacement 0,25cc
<b>0,45</b>	Displacement 0,45cc
<b>0,57</b>	Displacement 0,57cc
<b>0,76</b>	Displacement 0,76cc
<b>1,3</b>	Displacement 1,3cc

**Group 0**

**C Rotation**

A				B	C	D	E	F	G	H	I	J	K	L	M	N	O
			/		•									/			

<b>L</b>	Left rotation
<b>R</b>	Right rotation
<b>B</b>	Reversible pump

**D Project version**

A				B	C	D	E	F	G	H	I	J	K	L	M	N	O
			/		•									/			

<b>N</b>	Std gear version
----------	------------------

**E Mounting flange**

A				B	C	D	E	F	G	H	I	J	K	L	M	N	O
			/				•	•						/			

<b>Code</b>	<b>Description (Type of flange • Type of drive gear • Preferred ports for configuration)</b>
<b>01</b>	European 2-bolt flange

**F Drive gear**

A				B	C	D	E	F	G	H	I	J	K	L	M	N	O
			/					•	•					/			

<b>CA</b>	Tang drive 5xØ7
<b>FA</b>	Parallel shaft 7,0 mm [0.276 in]

**G Rear cover**

A				B	C	D	E	F	G	H	I	J	K	L	M	N	O
			/						•	•				/			

<b>P1</b>	Standard cover for pump
<b>P3</b>	Standard cover for reversible pump

**H Inlet size; I Outlet size**

A				B	C	D	E	F	G	H	I	J	K	L	M	N	O
			/							•	•	•	•	/			



**Group 0**

<b>D1</b>	M10x1- Threaded metric port	
<b>D3</b>	M14x1,5- Threaded metric port	
<b>F2</b>	1/4 GAS - Threaded BSP port	

**J Ports positions & Special body**

A					B					C	D	E	F	G	H	I	J	K	L	M					N	O	
																		•	•		/						

<b>NN</b>	Std position from catalog
-----------	---------------------------

**K Seals**

A					B					C	D	E	F	G	H	I	J	K	L	M					N	O	
																			•		/						

<b>N</b>	Standard Buna seal
----------	--------------------

**L Screws**

A					B					C	D	E	F	G	H	I	J	K	L	M					N	O	
																				•	/						

<b>N</b>	Std screws
----------	------------

**M Set valve**

A					B					C	D	E	F	G	H	I	J	K	L	M					N	O
																					/	•	•	•		

<b>NNN</b>	No valve
------------	----------

**N Type mark**

A					B					C	D	E	F	G	H	I	J	K	L	M					N	O	
																					/						•

<b>N</b>	Standard Danfoss Marking
----------	--------------------------

<b>A</b>	Standard Danfoss Marking+Customer Code
----------	--

**O Mark position**

A					B					C	D	E	F	G	H	I	J	K	L	M					N	O	
																					/						•

**Group 0**

<b>N</b>	Std Marking position (on top)
<b>A</b>	Special Marking position on the bottom

**Dimensions**
**TFP0NN-01FA**

Available 01FA configuration only.

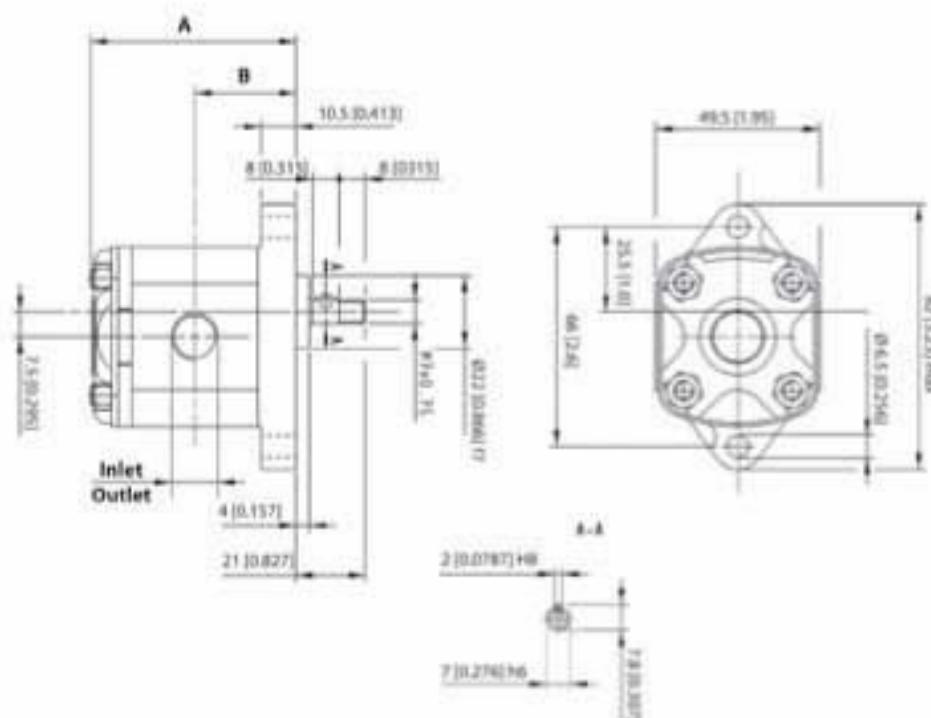

TFP0NN dimensions

Frame size		,25	,45	,57	,76	1,3
<b>Dimension</b>	<b>A</b>	53.5 [2.10]	55.0 [2.16]	56.0 [2.20]	61.5 [2.42]	61.5 [2.42]
	<b>B</b>	26.5 [1.04]	27.3 [1.07]	27.8 [1.09]	30.5 [1.20]	30.5 [1.20]
<b>Inlet/Outlet</b>		M10 x 1				

Model code examples and maximum shaft torque

Flange/drive gear	Model code example	Maximum shaft torque
<b>01FA</b>	TFP0NN/,57RN01FAP1D1D1N1NNN/NNNNN	4.5 N·m [39.8 lb·in]

 For further details on ordering, see [Product Code](#) on page 8.

**Group 1**

**Pump design**

**SNP1NN**

SNP1NN pumps only include European flange and shaft configurations (code 01BA, 01DA, and 03CA).

*SNP1NN 01BA (cut away)*

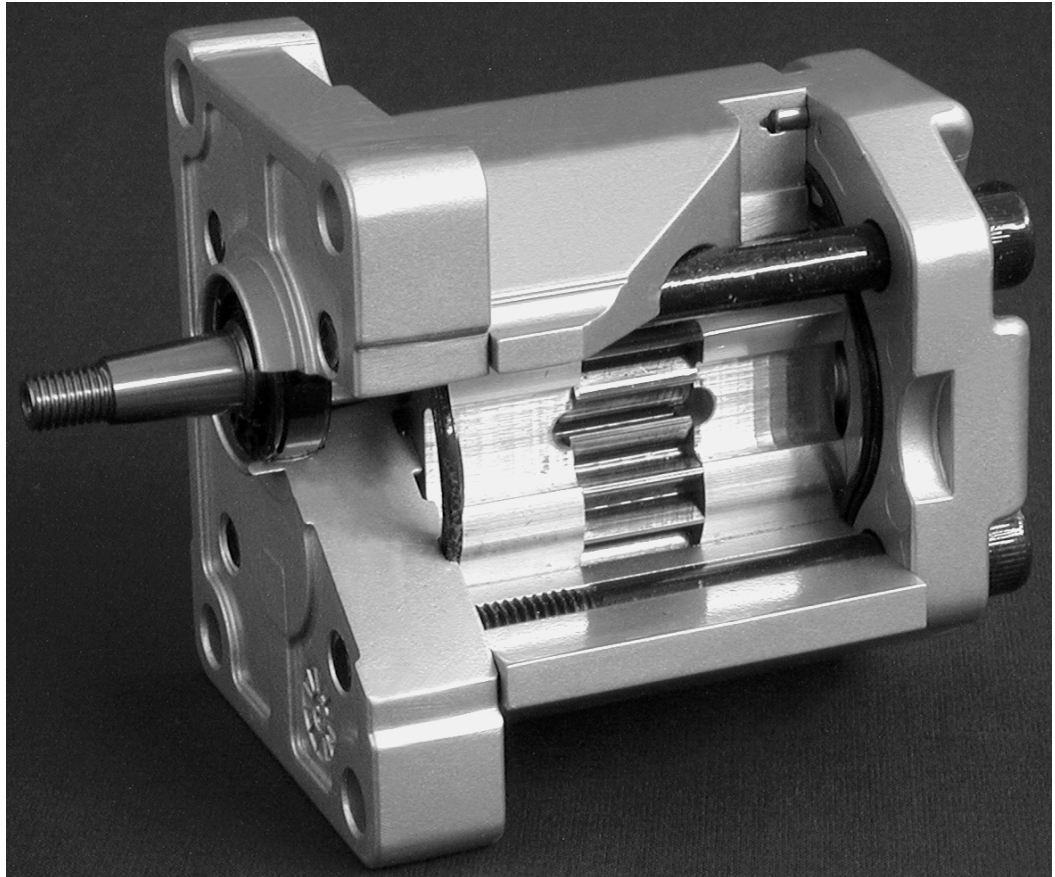

**Group 1**

**SKP1NN**

SKP1NN has a larger diameter shaft than the SNP1NN. It spans the complete displacement range at higher pressures than the SNP1IN and the SNP1NN. Configurations include European and SAE flanges and shafts (code 02BB, 02FA, 06SA, and 06GA).

**SKP1IN**

Danfoss offers an optional integral relief valve integrated in the rear cover. It is drained internally and directs all flow from the pump outlet to the inlet when the outlet pressure reaches the valve setting. SNI1 pumps only include European flange and shaft configurations (code 01BA, 01DA, and 03CA).

*SNP1IN 03CA (cut away)*

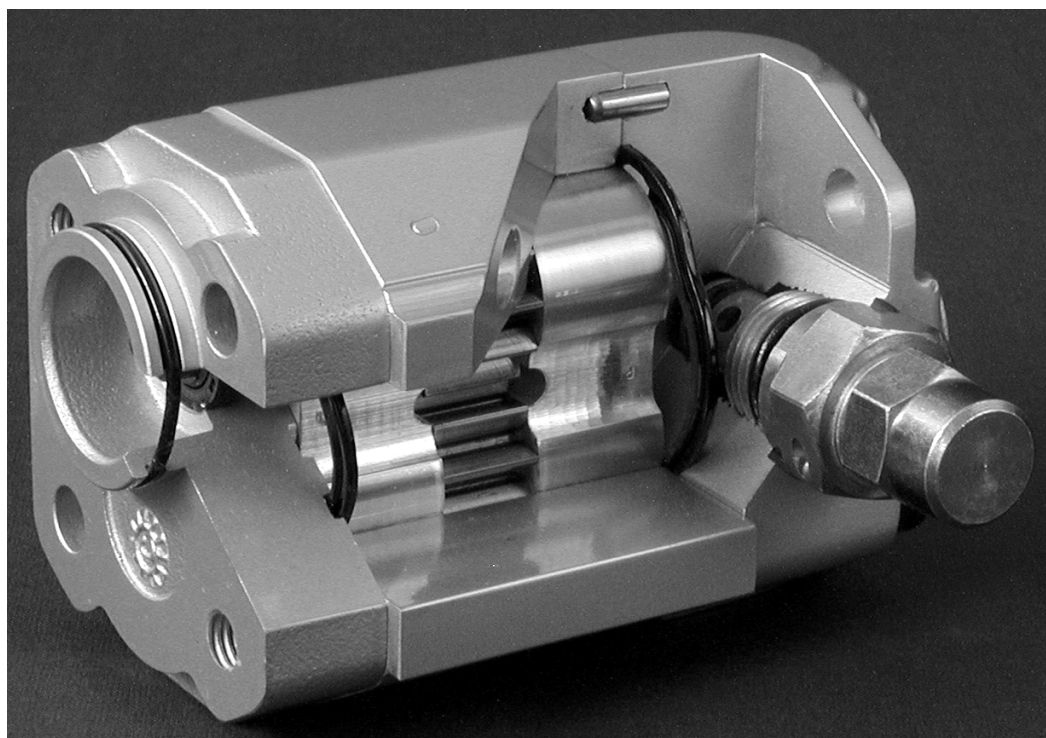

**Group 1**

**Pump displacements**

Quick reference chart for pump displacements vs. rated pressure

Quick reference chart for *pump* displacements vs. rated pressure

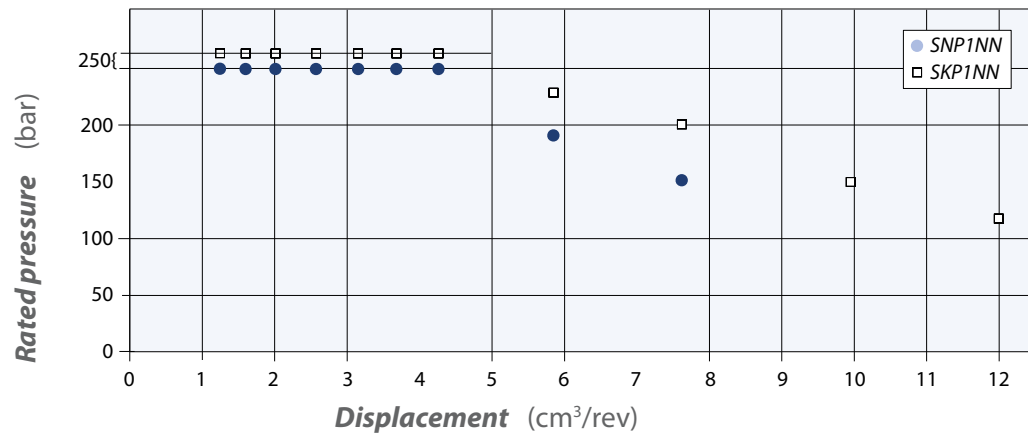

**General Information**
**Technical data**

		Frame size										
		1,2	1,7	2,2	2,6	3,2	3,8	4,3	6,0	7,8	010	012
<b>Displacement</b>	cm <sup>3</sup> /rev [in <sup>3</sup> /rev]	1.18 [0.072]	1.57 [0.096]	2.09 [0.128]	2.62 [0.160]	3.14 [0.192]	3.66 [0.223]	4.19 [0.256]	5.89 [0.359]	7.59 [0.463]	9.94 [0.607]	12.00 [0.732]
	<b>SNP1NN</b>											
<b>Peak pressure</b>	bar [psi]	270 [3915]	270 [3915]	270 [3915]	270 [3915]	270 [3915]	270 [3915]	270 [3915]	210 [3045]	170 [2465]		
<b>Rated pressure</b>		250 [3625]	250 [3625]	250 [3625]	250 [3625]	250 [3625]	250 [3625]	250 [3625]	190 [2760]	150 [2175]		
<b>Minimum speed at 0-150 bar</b>		800	800	600	600	600	600	500	500	500	-	-
<b>Min. speed at 150 bar to rated pressure</b>	min <sup>-1</sup> (rpm)	1200	1200	1000	1000	1000	1000	800	800	800		
<b>Maximum speed</b>		4000	4000	4000	4000	4000	4000	3000	3000	3000		
<b>SKP1NN*</b>												
<b>Peak pressure</b>	bar [psi]	270 [3915]	270 [3915]	270 [3915]	270 [3915]	270 [3915]	270 [3915]	270 [3915]	250 [3625]	220 [3190]	170 [2465]	140 [2030]
<b>Rated pressure</b>		250 [3625]	250 [3625]	250 [3625]	250 [3625]	250 [3625]	250 [3625]	250 [3625]	230 [3335]	200 [2900]	150 [2175]	120 [1740]
<b>Minimum speed at 0-150 bar</b>		800	800	800	800	800	800	600	600	600	600	600
<b>Min. speed at 150 bar to rated pressure</b>	min <sup>-1</sup> (rpm)	1200	1200	1000	1000	1000	1000	1000	800	800	800	-
<b>Maximum speed</b>		4000	4000	4000	4000	4000	4000	3000	3000	3000	2000	2000
<b>All (SNP1NN, SKP1NN)</b>												
<b>Weight</b>	kg [lb]	1.02 [2.26]	1.05 [2.31]	1.09 [2.40]	1.11 [2.45]	1.14 [2.51]	1.18 [2.60]	1.20 [2.65]	1.30 [2.87]	1.39 [3.06]	1.55 [3.42]	1.65 [3.64]
<b>Moment of inertia of rotating components</b>	x 10 <sup>-6</sup> kg·m <sup>2</sup> [x 10 <sup>-6</sup> lb·ft <sup>2</sup> ]	3.2 [77]	3.7 [89]	4.4 [105]	5.1 [120]	5.7 [136]	6.4 [152]	7.1 [168]	9.3 [220]	11.4 [271]	14.6 [347]	17.1 [407]
<b>Theoretical flow at maximum speed</b>	l/min [US gal/ min]	4.72 [1.25]	6.28 [1.66]	8.36 [2.21]	10.48 [2.77]	12.56 [3.32]	14.64 [3.87]	12.57 [3.32]	17.67 [4.67]	22.77 [6.02]	19.88 [5.25]	24 [6.34]

\*SKP1NN is a special version of the SNP1NN. It is designed to accommodate an SAE 9T 20/40 DP tooth splined shaft for higher torque applications.

$$1 \text{ kg}\cdot\text{m}^2 = 23.68 \text{ lb}\cdot\text{ft}^2$$

## General Information

 **Caution**

---

The rated and peak pressure mentioned are for pumps with flanged ports only. When threaded ports are required a derated performance has to be considered. To verify the compliance of an high pressure application with a threaded ports pump apply to a Danfoss representative.

---

**Product Code**

**Model code**

**A Family**

A	B	C	D	E	F	G	H	I	J	K	L	M	N	O
• • • • • /											/			

<b>SNB1NN</b>	Gear pump with inlet port on cover and outlet port on flange
<b>SNP1NN</b>	Standard gear pump
<b>SNC1NN</b>	Gear pump with inlet and outlet ports on rear cover
<b>SNP1IN</b>	Gear pump with internal drain relief valve
<b>SKP1NN</b>	High torque gear pump
<b>SKP1IN</b>	High torque gear pump with internal drain relief valve

**B Displacement**

A	B	C	D	E	F	G	H	I	J	K	L	M	N	O
/	• • •										/			

<b>1,2</b>	1,18 cc
<b>1,7</b>	1,57 cc
<b>2,2</b>	2,09 cc
<b>2,6</b>	2,62 cc
<b>3,2</b>	3,14 cc
<b>3,8</b>	3,66 cc
<b>4,3</b>	4,19 cc
<b>6,0</b>	5,89 cc
<b>7,8</b>	7,59 cc
<b>010</b>	9,94 cc
<b>012</b>	12,00 cc

**C Rotation**

A	B	C	D	E	F	G	H	I	J	K	L	M	N	O
/		•									/			

<b>L</b>	Left rotation
<b>R</b>	Right rotation

**D Project version**

A	B	C	D	E	F	G	H	I	J	K	L	M	N	O
/			•								/			

<b>N</b>	Standard gear pump
----------	--------------------



## Product Code

**E Mounting flange**

A				B				C	D	E	F	G	H	I	J	K	L	M				N	O									
										•	•																					

Code	Description (Type of flange • Type of drive gear • Preferred ports for configuration)
01	pilot Ø25,4+4 holes
02	pilot Ø30+4 holes
03	pilot Ø32+O-ring+2 holes through body
04	pilot Ø32+2 holes through body
06	SAE A-A pilot Ø50,8+ 2 holes

**F Drive gear**

A				B				C	D	E	F	G	H	I	J	K	L	M				N	O							
											•	•																		

AA	Taper 1:5-M6-Key 2
BA	Taper 1:8-M7-Key 2,41
BB	Taper 1:8-M10x1-Key 3
CA	Tang 5x Ø10 FR03
CE	Tang 6,63x Ø11 - for SKP1xN
CM	Tang 5x Ø10-type 03 + w/o coupling
DA	SplinedZ15-m0,75-alfa 30°-L14 - for SNP1xx
DB	SplinedZ15-m0,75-alfa 30°-L14 - for SKP1xx
FA	Parallel Ø12-Thread M10x1-Key 3
GA	Parallel Ø12,7-Key 3.2

**G Rear cover**

A				B				C	D	E	F	G	H	I	J	K	L	M				N	O						
												•	•																

03	Cover 03
08	Cover 08 with Inlet port 3/8" Gas
C1	Cover pump with front GAS Thread Inlet 3/8 ; Outlet 3/8
I1	Cover pump with relief valve
I3	Cover 03 with relief valve
P1	Std Cover pump

**H Inlet size; I Outlet size**

A				B				C	D	E	F	G	H	I	J	K	L	M				N	O							
													•	•	•	•														

**Product Code**

<b>NN</b>	Without inlet	
<b>B1</b>	8x30xM6	
<b>B2</b>	13x30xM6	
<b>C1</b>	8x26xM5	
<b>C2</b>	12x26xM5	
<b>C3</b>	13, 5x30xM6	
<b>D3</b>	M14x1,5	
<b>D5</b>	M18x1,5	
<b>D7</b>	M22x1,5	
<b>E3</b>	9/16-18UNF	
<b>E4</b>	3/4-16UNF	
<b>E5</b>	7/8-14UNF	
<b>F2</b>	1/4 GAS	
<b>F3</b>	3/8 GAS	
<b>F4</b>	1/2 GAS	
<b>H2</b>	10xM12x1,5-ISO6149	
<b>H4</b>	12xM16x1,5-ISO6149	
<b>H5</b>	12xM18x 1, 5-ISO6149	
<b>H7</b>	13, 5xM22x 1, 5-ISO6149	

**J Ports positions & Special body**

A	B	C	D	E	F	G	H	I	J	K	L	M	N	O
	/								•	•	/			

<b>NN</b>	Std from catalogue
-----------	--------------------

**K Seals**

A	B	C	D	E	F	G	H	I	J	K	L	M	N	O
	/									•	/			

**Product Code**

<b>N</b>	Standard NBR seal
<b>A</b>	Without shaft seal
<b>B</b>	With VITON seals

**L Screws**

A					B	C	D	E	F	G	H	I	J	K	L	M					N	O		
					/											•	/							

<b>N</b>	Std screws
<b>B</b>	GEOMET screws

**M Set valve**

A					B	C	D	E	F	G	H	I	J	K	L	M					N	O			
					/											/	•	•	•						

<b>NNN</b>	No valve
<b>V**</b>	not defined-pressure no setting :oil ISO VG68-45°

**N Type mark**

A					B	C	D	E	F	G	H	I	J	K	L	M					N	O		
					/											/								•

<b>N</b>	Standard Danfoss Marking
<b>A</b>	Standard Danfoss Marking+Customer Code
<b>Z</b>	Without Marking

**O Mark position**

A					B	C	D	E	F	G	H	I	J	K	L	M					N	O		
					/											/								•

<b>N</b>	Std Marking position (on top)
<b>A</b>	Special Marking position on the bottom

**Determination of Nominal Pump Sizes**
**Determination of nominal pump sizes**

Use these formula to determine the nominal pump size for a specific application:

**Based on SI units**
**Based on US units**

$$\text{Output flow: } Q = \frac{Vg \cdot n \cdot \eta_v}{1000} \quad \text{l/min}$$

$$Q = \frac{Vg \cdot n \cdot \eta_v}{231} \quad \text{[US gal/min]}$$

$$\text{Input torque: } M = \frac{Vg \cdot \Delta p}{20 \cdot \pi \cdot \eta_m} \quad \text{N}\cdot\text{m}$$

$$M = \frac{Vg \cdot \Delta p}{2 \cdot \pi \cdot \eta_m} \quad \text{[lbf}\cdot\text{in]}$$

$$\text{Input power: } P = \frac{M \cdot n}{9550} = \frac{Q \cdot \Delta p}{600 \cdot \eta_t} \quad \text{kW}$$

$$P = \frac{M \cdot n}{63.025} = \frac{Q \cdot \Delta p}{1714 \cdot \eta_t} \quad \text{[hp]}$$

$Vg =$	Displacement per rev.	cm <sup>3</sup> /rev [in <sup>3</sup> /rev]
$p_{HD} =$	Outlet pressure	bar [psi]
$p_{ND} =$	Inlet pressure	bar [psi]
$\Delta p =$	$p_{HD} - p_{ND}$	bar [psi]
$n =$	Speed	min <sup>-1</sup> (rpm)
$\eta_v =$	Volumetric efficiency	
$\eta_m =$	Mechanical (torque) efficiency	
$\eta_t =$	Overall efficiency ( $\eta_v \cdot \eta_m$ )	

## System Requirements

### Pressure

The inlet vacuum must be controlled in order to realize expected pump life and performance. The system design must meet inlet pressure requirements during all modes of operation. Expect lower inlet pressures during cold start. It should improve quickly as the fluid warms.

<b>Max. continuous vacuum</b>	bar abs. [in. Hg]	0.8 [23.6]
<b>Max. intermittent vacuum</b>		0.6 [17.7]
<b>Max. pressure</b>		3.0 [88.5]

**Peak pressure** is the highest intermittent pressure allowed. The relief valve overshoot (reaction time) determines peak pressure. It is assumed to occur for less than 100 ms. The accompanying illustration shows peak pressure in relation to rated pressure and reaction time (100 ms maximum).

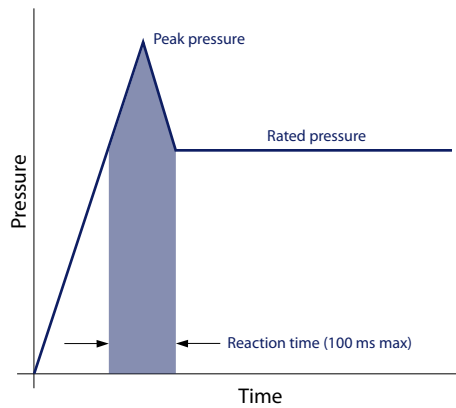

**Rated pressure** is the average, regularly occurring, operating pressure that should yield satisfactory product life. The maximum machine load demand determines rated pressure. For all systems, the load should move below this pressure.

**System pressure** is the differential of pressure between the outlet and inlet ports. It is a dominant operating variable affecting hydraulic unit life. High system pressure, resulting from high load, reduces expected life. System pressure must remain at, or below, rated pressure during normal operation to achieve expected life.

### Speed

**Maximum speed** is the limit recommended by Danfoss for a particular gear pump when operating at rated pressure. It is the highest speed at which normal life can be expected.

The lower limit of operating speed is the **minimum speed**. It is the lowest speed at which normal life can be expected. The minimum speed increases as operating pressure increases. When operating under higher pressures, a higher minimum speed must be maintained, as illustrated here.

## System Requirements

*Speed versus pressure*

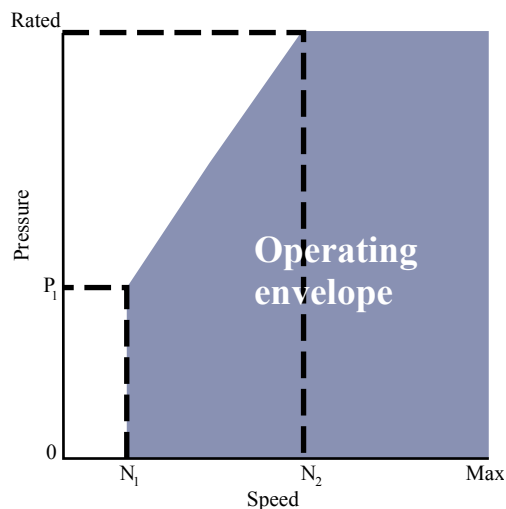

Where:

$N_1$  = Minimum speed at 100 bar

$N_2$  = Minimum speed at 180 bar

## Hydraulic fluids

Ratings and data for SNP1NN, and SKP1NN gear pumps are based on operating with premium hydraulic fluids containing oxidation, rust, and foam inhibitors. These fluids must possess good thermal and hydrolytic stability to prevent wear, erosion, and corrosion of internal components. They include:

- Hydraulic fluids following DIN 51524, part 2 (HLP) and part 3 (HVL) specifications
- API CD engine oils conforming to SAE J183
- M2C33F or G automatic transmission fluids
- Certain agricultural tractor fluids

Use only clean fluid in the pump and hydraulic circuit.

**! Caution**

**Never mix hydraulic fluids.**

## Temperature and viscosity

**Temperature and viscosity requirements** must be concurrently satisfied. Use petroleum / mineral-based fluids.

High temperature limits apply at the inlet port to the pump. The pump should run at or below the maximum continuous temperature. The peak temperature is based on material properties. Don't exceed it.

Cold oil, generally, doesn't affect the durability of pump components. It may affect the ability of oil to flow and transmit power. For this reason, keep the temperature at 16 °C [60 °F] above the pour point of the hydraulic fluid.

Minimum (cold start) temperature relates to the physical properties of component materials.

Minimum viscosity occurs only during brief occasions of maximum ambient temperature and severe duty cycle operation. You will encounter maximum viscosity only at cold start. During this condition, limit speeds until the system warms up. Size heat exchangers to keep the fluid within these limits. Test regularly to verify that these temperatures and viscosity limits aren't exceeded. For maximum unit efficiency and bearing life, keep the fluid viscosity in the recommended viscosity range.

## System Requirements

### Fluid viscosity

<b>Maximum (cold start)</b>	mm <sup>2</sup> /s [SUS]	1000 [4600]
<b>Recommended range</b>		12-60 [66-290]
<b>Minimum</b>		10 [60]

### Temperature

<b>Minimum (cold start)</b>	°C [°F]	-20 [-4]
<b>Maximum continuous</b>		80 [176]
<b>Peak (intermittent)</b>		90 [194]

## Filtration

### Filters

Use a filter that conforms to Class 22/18/13 of ISO 4406 (or better). It may be on the pump outlet (pressure filtration), inlet (suction filtration), or reservoir return (return-line filtration).

### Selecting a filter

When selecting a filter, please consider:

- contaminant ingress rate (determined by factors such as the number of actuators used in the system)
- generation of contaminants in the system
- required fluid cleanliness
- desired maintenance interval
- filtration requirements of other system components

Measure filter efficiency with a Beta ratio ( $\beta_x$ ). For:

- suction filtration, with controlled reservoir ingress, use a  $\beta_{35-45} = 75$  filter
- return or pressure filtration, use a pressure filtration with an efficiency of  $\beta_{10} = 75$

$\beta_x$  ratio is a measure of filter efficiency defined by ISO 4572. It is the ratio of the number of particles greater than a given diameter ("x" in microns) upstream of the filter to the number of these particles downstream of the filter.

### Fluid cleanliness level and $\beta_x$ ratio

<b>Fluid cleanliness level (per ISO 4406)</b>	Class 22/18/13 or better
<b><math>\beta_x</math> ratio (suction filtration)</b>	$\beta_{35-45} = 75$ and $\beta_{10} = 2$
<b><math>\beta_x</math> ratio (pressure or return filtration)</b>	$\beta_{10} = 75$
<b>Recommended inlet screen size</b>	100-125 $\mu\text{m}$ [0.004-0.005 in]

The filtration requirements for each system are unique. Evaluate filtration system capacity by monitoring and testing prototypes.

### Reservoir

The **reservoir** provides clean fluid, dissipates heat, removes entrained air, and allows fluid volume changes associated with fluid expansion and cylinder differential volumes. A correctly sized reservoir accommodates maximum volume changes during all system operating modes. It promotes deaeration of the fluid as it passes through, and accommodates a fluid dwell-time between 60 and 180 seconds, allowing entrained air to escape.

## System Requirements

**Minimum reservoir capacity** depends on the volume required to cool and hold the oil from all retracted cylinders, allowing for expansion due to temperature changes. A fluid volume of 1 to 3 times the pump output flow (per minute) is satisfactory. The minimum reservoir capacity is 125% of the fluid volume.

Install the suction line above the bottom of the reservoir to take advantage of gravity separation and prevent large foreign particles from entering the line. Cover the line with a 100-125 micron screen. The pump should be below the lowest expected fluid level. Put the return-line below the lowest expected fluid level to allow discharge into the reservoir for maximum dwell and efficient deaeration. A baffle (or baffles) between the return and suction lines promotes deaeration and reduces fluid surges.

## Line sizing

Choose pipe sizes that accommodate minimum fluid velocity to reduce system noise, pressure drops, and overheating. This maximizes system life and performance.

Design inlet piping that maintains continuous pump inlet pressure above 0.8 bar absolute during normal operation. The line velocity should not exceed the values in this table:

### Maximum line velocity

<b>Inlet</b>	m/s [ft/sec]	2.5 [8.2]
<b>Outlet</b>		5.0 [16.4]
<b>Return</b>		3.0 [9.8]

Most systems use hydraulic oil containing 10% dissolved air by volume. Under high inlet vacuum conditions the oil releases bubbles. They collapse when subjected to pressure, resulting in cavitation, causing adjacent metal surfaces to erode. **Over-aeration** is the result of air leaks on the inlet side of the pump, and flow-line restrictions. These include inadequate pipe sizes, sharp bends, or elbow fittings, causing a reduction of flow line cross sectional area. This problem will not occur if inlet vacuum and rated speed requirements are maintained, and reservoir size and location are adequate.

## Pump drive

Shaft options for Group 1 gear pumps include tapered, tang, splined, or parallel shafts. They are suitable for a wide range of direct and indirect drive applications for radial and thrust loads.

**Plug-in drives**, acceptable only with a splined shaft, can impose severe radial loads when the mating spline is rigidly supported. Increasing spline clearance does not alleviate this condition.

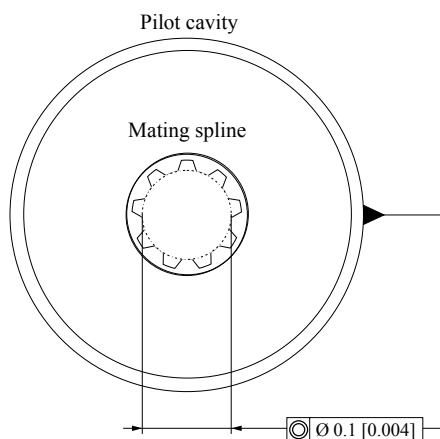

Use **plug-in drives** if the concentricity between the mating spline and pilot diameter is within 0.1 mm [0.004 in]. Lubricate the drive by flooding it with oil. A 3-piece coupling minimizes radial or thrust shaft loads.



## System Requirements

**⚠ Caution**

In order to avoid spline shaft damages it is recommended to use carburized and hardened steel couplings with 80-82 HRA surface hardness.

Allowable **radial shaft loads** are a function of the load position, load orientation, and operating pressure of the hydraulic pump. All external shaft loads have an effect on bearing life, and may affect pump performance.

In applications where external shaft loads can't be avoided, minimize the impact on the pump by optimizing the orientation and magnitude of the load. Use a tapered input shaft; don't use splined shafts for belt or gear drive applications. A spring-loaded belt tension-device is recommended for belt drive applications to avoid excessive tension. Avoid thrust loads in either direction.

## Pump drive data form

Contact Danfoss if continuously applied external radial or thrust loads occur. Fill out this page and send the complete form to your Danfoss representative for an assistance in applying pumps with belt or gear drive. This illustration shows a pump with counterclockwise orientation:

### Optimal radial load position

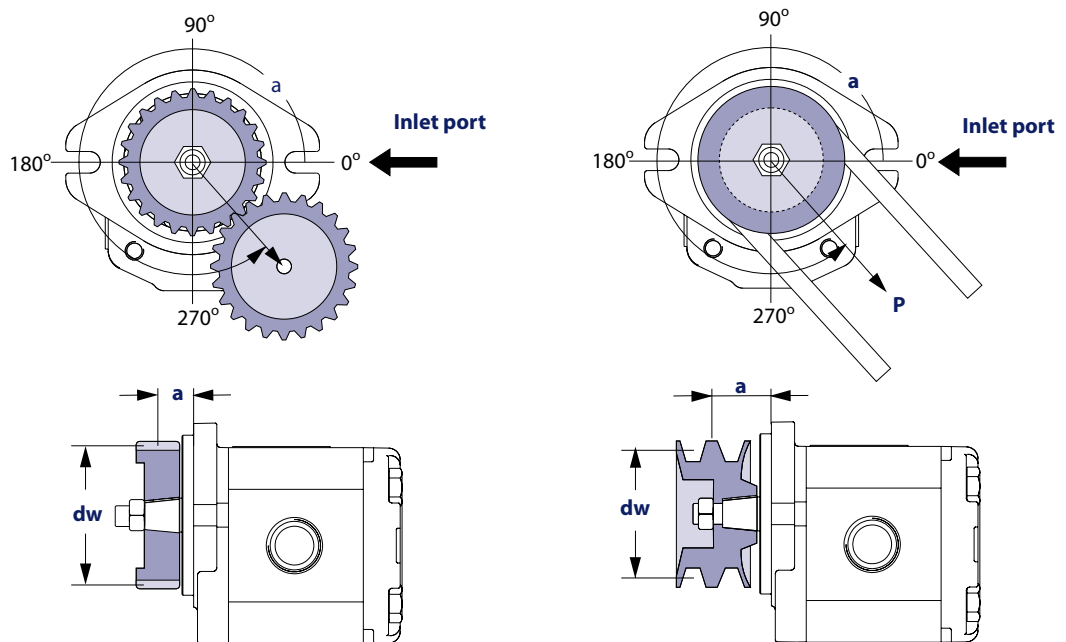

### Application data

Item	Value	Unit
Pump displacement		cm <sup>3</sup> /rev [in <sup>3</sup> /rev]
Rated system pressure		bar psi
Relief valve setting		
Pump shaft rotation		left right
Pump minimum speed		min <sup>-1</sup> (rpm)
Pump maximum speed		
Drive gear helix angle (gear drive only)		degree
Belt type (gear drive only)		V notch
Belt tension (gear drive only)	<b>P</b>	N lbf

## System Requirements

*Application data (continued)*

Item		Value	Unit
Angular orientation of gear or belt to inlet port	$\alpha$		degree
Pitch diameter of gear or pulley	$dw$		mm in
Distance from flange to center of gear or pulley	$a$		

## Pump Life

Pump life is a function of speed, system pressure, and other system parameters (such as fluid quality and cleanliness).

All Danfoss gear pumps use hydrodynamic journal bearings that have an oil film maintained between the gear/shaft and bearing surfaces at all times. If the oil film is sufficiently sustained through proper system maintenance and operating within recommended limits, long life can be expected.

[B<sub>10</sub> life expectancy number is generally associated with rolling element bearings. It does not exist for hydrodynamic bearings.](#)

High pressure, resulting from high loads, impacts pump life. When submitting an application for review, provide machine duty cycle data that includes percentages of time at various loads and speeds. We strongly recommend a prototype testing program to verify operating parameters and their impact on life expectancy before finalizing any system design.

## Sound levels

Noise is unwanted sound. Fluid power systems create noise. There are many techniques available to minimize noise. Understanding how it's generated and transmitted is necessary to apply these methods effectively.

Noise energy is transmitted as fluid borne noise (pressure ripple) or structure borne noise. **Pressure ripple** is the result of the number of pumping elements (gear teeth) delivering oil to the outlet and the pump's ability to gradually change the volume of each pumping element from low to high pressure. Pressure ripple is affected by the compressibility of the oil as each pumping element discharges into the outlet of the pump. Pressure pulsations travel along hydraulic lines at the speed of sound (about 1400 m/s in oil) until there is a change in the system (as with an elbow fitting). Thus, the pressure pulsation amplitude varies with overall line length and position.

**Structure borne noise** may be transmitted wherever the pump casing is connected to the rest of the system.

The way circuit components respond to excitation depends on their size, form, and mounting. Because of this, a system line may actually have a greater noise level than the pump. To minimize noise, use:

- flexible hoses (if you must use steel plumbing, clamp the lines).
- flexible (rubber) mounts to minimize other structure borne noise.

**Pump Performance**

**Pump performance graphs**

The following graphs provide typical output flow and input power for Group 1 pumps at various working pressures. Data were taken using ISO VG46 petroleum /mineral based fluid at 50°C (viscosity at 28 mm<sup>2</sup>/s [cSt]).

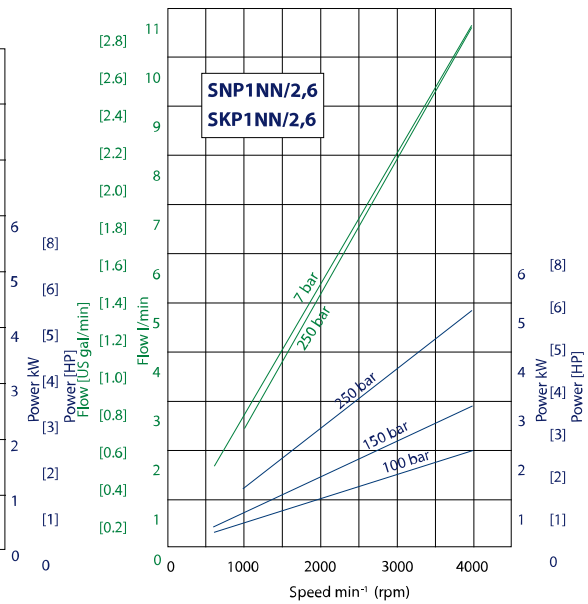
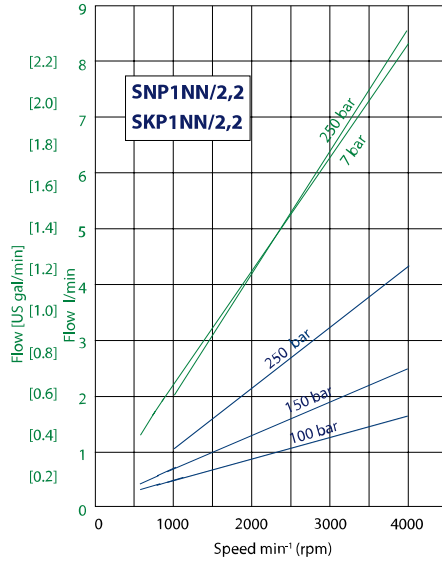
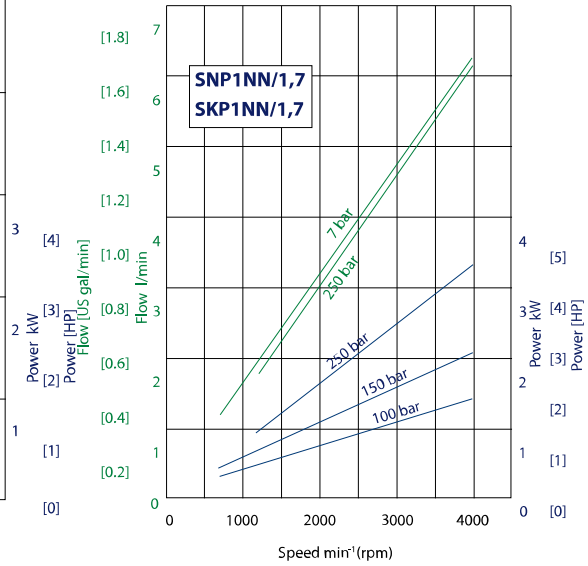
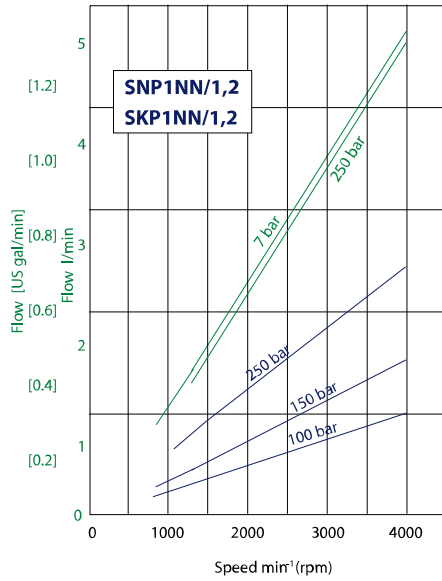

**Pump Performance**

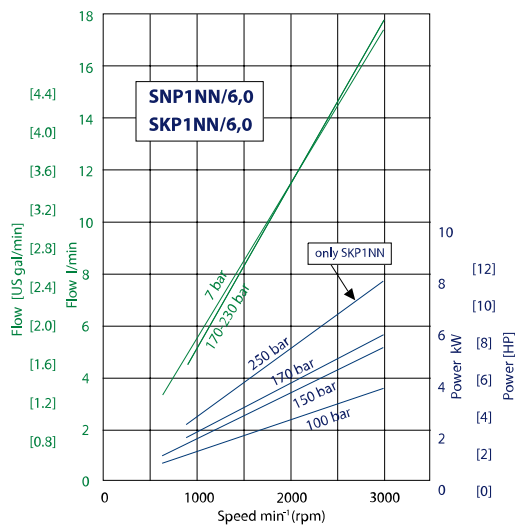
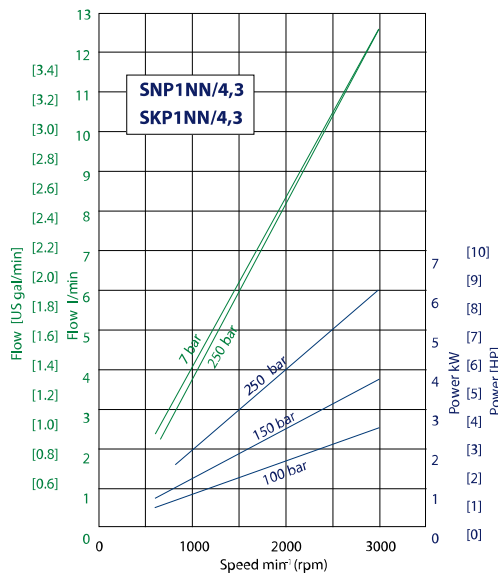
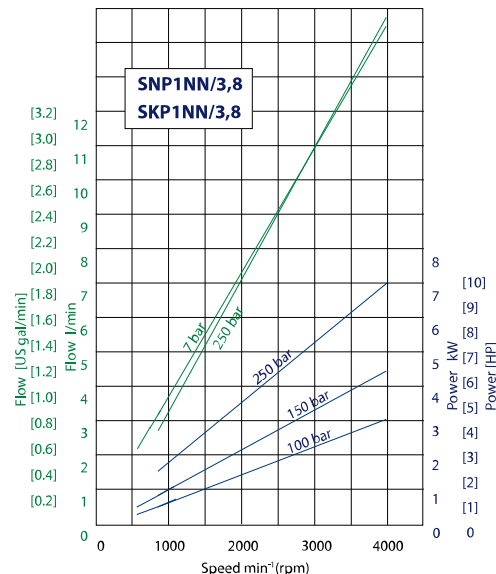
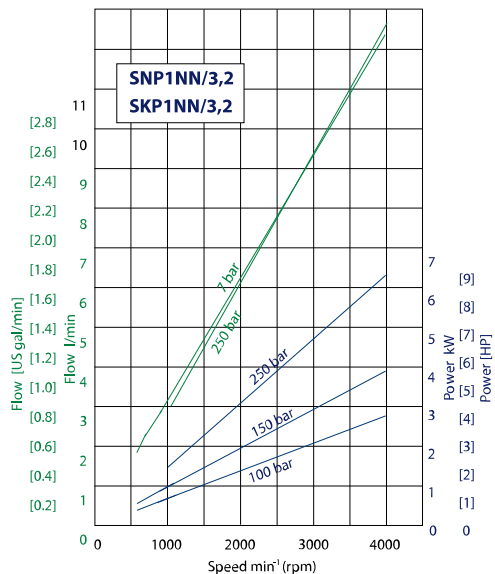

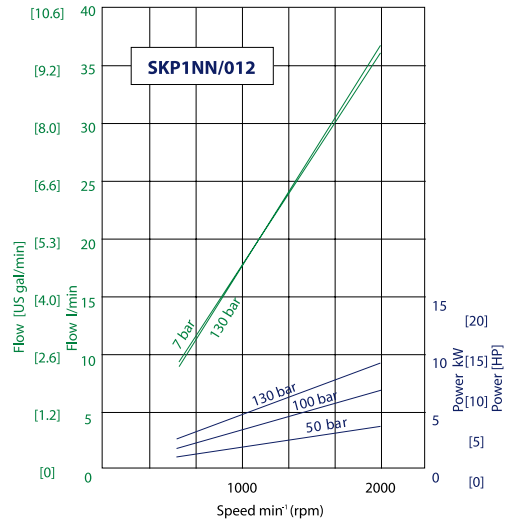
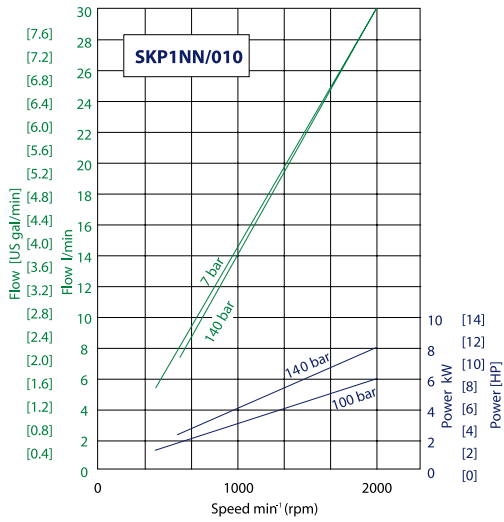
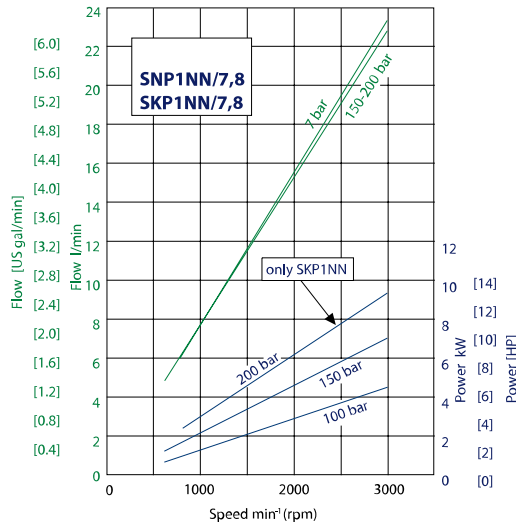

**Pump Performance**





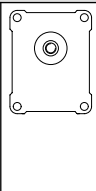
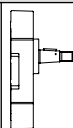
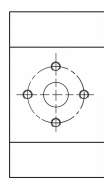
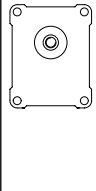
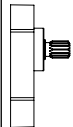
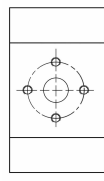

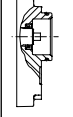
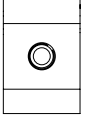
**Product Options**

**Flange, shaft and port configurations**

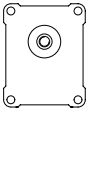
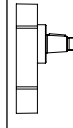
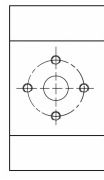
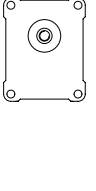
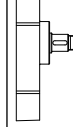
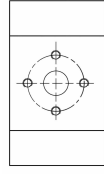
Code	Flange	Shaft	Port
<b>01BA</b>	25.4 mm [1.0 in] pilot Ø European 4-bolt 	1:8 tapered 	European flanged in + pattern 
<b>01DA</b>	25.4 mm [1.0 in] pilot Ø European 4-bolt 	15-teeth splined m = 0.75 a = 30o 	European flanged in + pattern 
<b>03CA</b>	pilot Ø32 + O-ring + 2 holes through body 	Danfoss tang 	Threaded metric port 

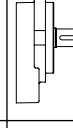
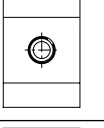
*Flange, shaft and port configurations for SKP1NN*

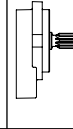
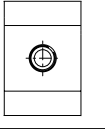
Code	Flange	Shaft	Port
<b>02BB</b>	30 mm [1.181] pilot Ø European 4- bolt 	1:8 tapered 	European flanged in + pattern 
<b>02FA</b>	30 mm [1.181] pilot Ø European 4- bolt 	12 mm [0.472 in] parallel 	European flanged in + pattern 
<b>06GA</b>	SAE A-A 2-bolt 	12.7 mm [0.5 in] parallel 	Threaded SAE O- Ring boss 
<b>06SA</b>	SAE A-A 2-bolt 	9-teeth splined SAE spline J 498-9T-20/40DP 	Threaded SAE O- Ring boss 

## Product Options

## Shaft options

Direction is viewed facing the shaft. Group 1 pumps are available with a variety of tang, splined, parallel, and tapered shaft ends. Not all shaft styles are available with all flange styles.

## Shaft availability and nominal torque capability

A	B	C	D	E	F	G	H	I	J	K	L	M	N	O
					•	•								

Shaft		Mounting flange code with maximum torque in Nm [lb-in]							
Code	Description	01	02	03	04	06	08	B1	V6
AA	Taper 1:5-M6				25 [221]				
BA	Taper 1:8-M7	25 [221]							
BB	Taper 1:8-M10		50 [442]						
BG	Taper 1:8-M7-shaft for short version							25 [221]	
CA	Tang 5x Ø10			14 [124]					
CD	Tang 5x Ø11,5 distance from gear face 47,5						17 [150]		
CE	Tang 6,63x Ø11					21 [186]			
CF	Tang 5x Ø11,5 distance from gear face 35	21 [186]							
CM	Tang 5x Ø10-type 03 + w/o coupling			14 [124]					
DA	Splined Z15-m0,75-alfa 30°-L14	35 [309]							
DB	Splined Z15-m0,75-alfa 30°-L14		35 [309]						
DC	Splined B12x9-L14-flange protrusion sb22-Z6-m1,60- alfa 30°	30 [265]							
DD	Splined B12x9-L20-flange protrusion sb40-Z6-m1,75- alfa 30°		30 [265]						
FA	Parallel Ø12-Thread M10x1		24 [212]						
GA	Parallel Ø12,7-Key 3.2					32 [283]			
SA	SAE spline J498-9T-20/40					34 [301]			34 [301]
SG	SAE spline J498-8T-16/32-shaft for short version					34 [301]			

Danfoss recommends mating splines conform to SAE J498 or DIN 5482.

Danfoss external SAE splines have a flat root side fit with circular tooth thickness reduced by 0.127 mm [0.005 in] in respect to class 1 fit. Dimensions are modified to assure a clearance fit with the mating spline.

**! Caution**

Shaft torque capability may limit allowable pressure. Torque ratings assume no external radial loading. Applied torque must not exceed these limits, regardless of stated pressure parameters. Maximum torque ratings are based on shaft torsional fatigue strength.

Various port configurations are available on Group 1 pumps. They include:

**Product Options**

- European standard flanged ports
- German standard flanged ports
- Gas threaded ports (BSPP)
- O-Ring boss (following SAE J1926/1 [ISO 11926-1] UNF threads, standard)

For a table of dimensions, see [Ports](#) on page 33.

**Inlet/Outlet port configurations**

A	B	C	D	E	F	G	H	I	J	K	L	M	N	O
							•	•	•	•				
<b>B1</b>	8x30xM6	Flanged port with threaded holes in X pattern, in center of body												
<b>B2</b>	13x30xM6													
<b>C1</b>	8x26xM5	Flanged port with threaded holes in + pattern (European standard ports)												
<b>C2</b>	12x26xM5													
<b>C3</b>	13,5x30xM6													
<b>D3</b>	M14x1,5	Threaded metric port												
<b>D5</b>	M18x1,5													
<b>D7</b>	M22x1,5													
<b>E3</b>	9/16-18UNF	Threaded SAE, O-Ring boss port												
<b>E4</b>	3/4 -16UNF													
<b>E5</b>	7/8-14UNF													
<b>F2</b>	1/4 GAS	Threaded GAS (BSPP) port												
<b>F3</b>	3/8 GAS													
<b>F4</b>	1/2 GAS													
<b>H5</b>	M18x1,5	Threaded metric port ISO 6149												
<b>H7</b>	M22x1,5													

**Ports**

Available ports

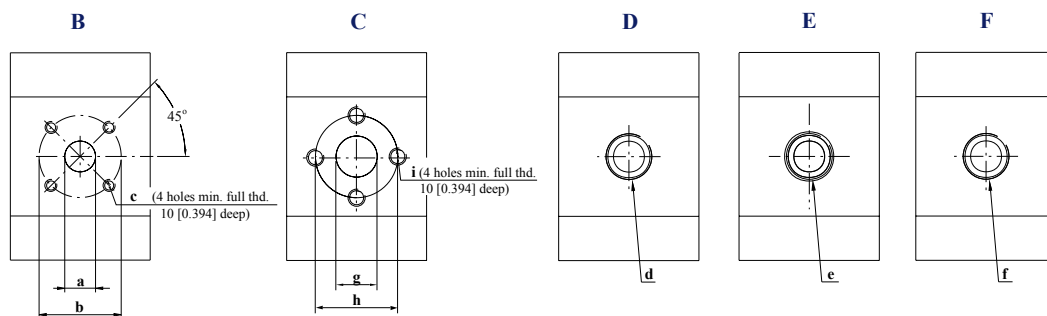



## Product Options

Dimensions of Group 1 pump ports

Port type		B			C			D	E	F
Port dimension		a	b	c	g	h	i	d	e	f
1,2	Inlet	13 [0.512]	30 [1.181]	M6	12 [0.462]	26 [1.024]	M5	M18x1.5	¾-16UNF-2B	3/8 Gas (BSPP)
	Outlet	8 [0.315]	30 [1.181]	M6	12 [0.462]	26 [1.024]	M5	M14x1.5	9/16-18UNF-2B	3/8 Gas (BSPP)
1,7	Inlet	13 [0.512]	30 [1.181]	M6	12 [0.462]	26 [1.024]	M5	M18x1.5	¾-16UNF-2B	3/8 Gas (BSPP)
	Outlet	8 [0.315]	30 [1.181]	M6	12 [0.462]	26 [1.024]	M5	M14x1.5	9/16-18UNF-2B	3/8 Gas (BSPP)
2,2	Inlet	13 [0.512]	30 [1.181]	M6	12 [0.462]	26 [1.024]	M5	M18x1.5	¾-16UNF-2B	3/8 Gas (BSPP)
	Outlet	8 [0.315]	30 [1.181]	M6	12 [0.462]	26 [1.024]	M5	M14x1.5	9/16-18UNF-2B	3/8 Gas (BSPP)
2,6	Inlet	13 [0.512]	30 [1.181]	M6	12 [0.462]	26 [1.024]	M5	M18x1.5	¾-16UNF-2B	3/8 Gas (BSPP)
	Outlet	8 [0.315]	30 [1.181]	M6	12 [0.462]	26 [1.024]	M5	M14x1.5	9/16-18UNF-2B	3/8 Gas (BSPP)
3,2	Inlet	13 [0.512]	30 [1.181]	M6	12 [0.462]	26 [1.024]	M5	M18x1.5	¾-16UNF-2B	3/8 Gas (BSPP)
	Outlet	8 [0.315]	30 [1.181]	M6	12 [0.462]	26 [1.024]	M5	M14x1.5	9/16-18UNF-2B	3/8 Gas (BSPP)
3,8	Inlet	13 [0.512]	30 [1.181]	M6	12 [0.462]	26 [1.024]	M5	M18x1.5	¾-16UNF-2B	3/8 Gas (BSPP)
	Outlet	8 [0.315]	30 [1.181]	M6	12 [0.462]	26 [1.024]	M5	M18x1.5	9/16-18UNF-2B	3/8 Gas (BSPP)
4,3	Inlet	13 [0.512]	30 [1.181]	M6	12 [0.462]	26 [1.024]	M5	M18x1.5	¾-16UNF-2B	3/8 Gas (BSPP)
	Outlet	8 [0.315]	30 [1.181]	M6	12 [0.462]	26 [1.024]	M5	M18x1.5	9/16-18UNF-2B	3/8 Gas (BSPP)
6,0	Inlet	13 [0.512]	30 [1.181]	M6	12 [0.462]	26 [1.024]	M5	M18x1.5	¾-16UNF-2B	3/8 Gas (BSPP)
	Outlet	13 [0.512]	30 [1.181]	M6	12 [0.462]	26 [1.024]	M5	M18x1.5	9/16-18UNF-2B	3/8 Gas (BSPP)
7,8	Inlet	13 [0.512]	30 [1.181]	M6	12 [0.462]	26 [1.024]	M5	M18x1.5	¾-16UNF-2B	3/8 Gas (BSPP)
	Outlet	13 [0.512]	30 [1.181]	M6	12 [0.462]	26 [1.024]	M5	M18x1.5	9/16-18UNF-2B	3/8 Gas (BSPP)
010	Inlet	13 [0.512]	30 [1.181]	M6	12 [0.462]	26 [1.024]	M5	M18x1.5	¾-16UNF-2B	3/8 Gas (BSPP)
	Outlet	13 [0.512]	30 [1.181]	M6	12 [0.462]	26 [1.024]	M5	M18x1.5	9/16-18UNF-2B	3/8 Gas (BSPP)
012	Inlet	13 [0.512]	30 [1.181]	M6	12 [0.462]	26 [1.024]	M5	M18x1.5	¾-16UNF-2B	3/8 Gas (BSPP)
	Outlet	13 [0.512]	30 [1.181]	M6	12 [0.462]	26 [1.024]	M5	M18x1.5	9/16-18UNF-2B	3/8 Gas (BSPP)

## SNP1IN

Danfoss offers an optional integral relief valve integrated in the rear cover. It is drained internally and directs all flow from the pump outlet to the inlet when the outlet pressure reaches the valve setting.

**Caution**

When the relief valve is operating in bypass condition, rapid heat generation occurs. If this bypass condition continues, the pump prematurely fails. The reason for this is that it is a rule, not an exception.

**Product Options**

*Valve performance graph*

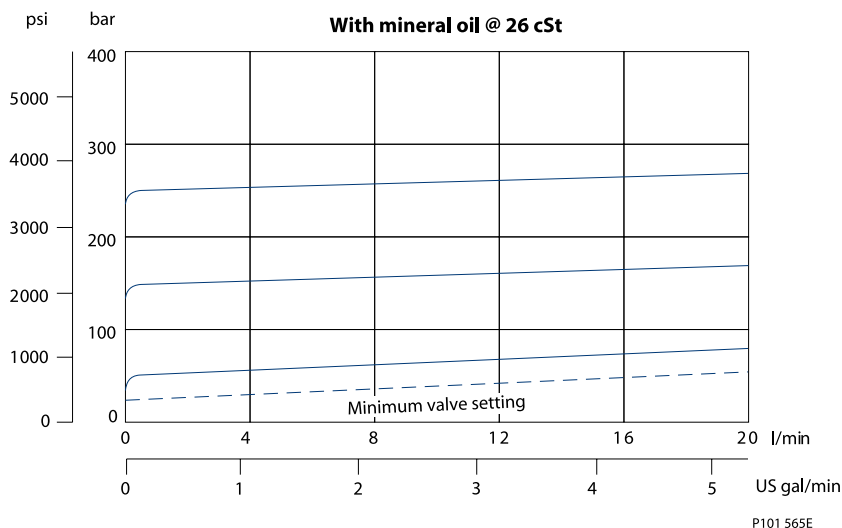

*Dimensions*

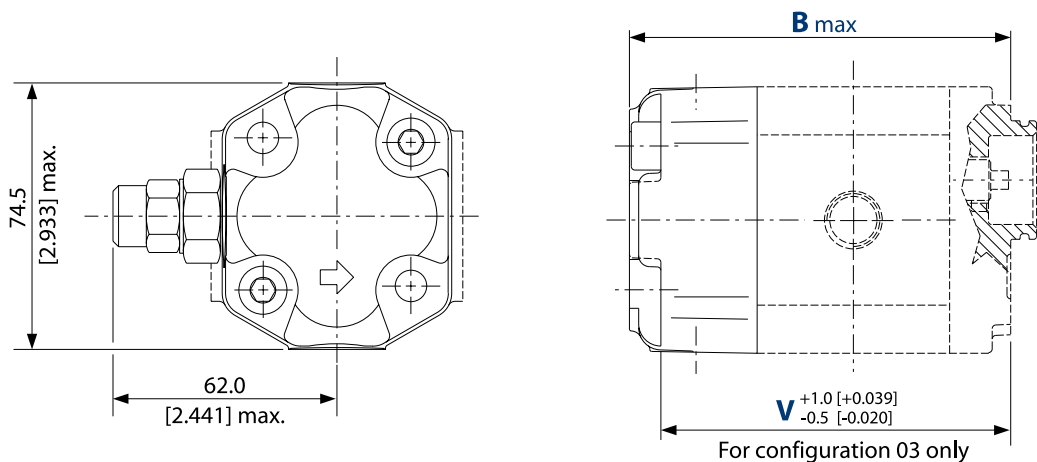

For configuration 06 (SAE A-A) dimension B and V have to be increased 4.5 mm [0.177 in].

*Integral relief valve and covers dimensions*

Type (displacement)	1,2	1,7	2,2	2,6	3,2	3,8	4,3	6,0	7,8	010	012	
Dimensions mm [in]	<b>B</b>	95.5 [3.760]	97 [3.819]	99 [3.989]	101 [3.976]	103 [4.055]	105 [4.134]	107 [4.213]	113.5 [4.468]	120 [4.724]	129 [5.079]	137 [5.394]
	<b>V</b>	85.0 [3.346]	86.5 [3.406]	88.5 [3.484]	90.5 [3.563]	92.5 [3.642]	94.5 [3.720]	96.5 [3.799]	103.0 [4.055]	109.5 [4.311]	118.5 [4.665]	126.5 [4.980]

**Variant codes for ordering integral relief valves**

These tables detail the various codes for ordering integral relief valves:

A	B	C	D	E	F	G	H	I	J	K	L	M	N	O
/											/	•	•	•

**Product Options**

Code	Pump speed for RV setting min-1 (rpm)
A	Not defined
C	500
E	1000
F	1250
G	1500
K	2000
I	2250
L	2500
M	2800
N	3000
O	3250

Code	Pressure setting bar [psi]
A	No setting
B	No valve
C	18 [261]
D	25 [363]
E	30 [435]
F	35 [508]
G	40 [580]
K	50 [725]
L	60 [870]
M	70 [1015]
N	80 [1160]
O	90 [1305]
P	100 [1450]
Q	110 [1595]
R	120 [1740]
S	130 [1885]
T	140 [2030]
U	160 [2320]
V	170 [2465]
W	180 [2611]
X	210 [3045]
Y	240 [3480]
Z	250 [3626]

**Product Options**

**Integral relief valve schematic**

*Valve schematic*

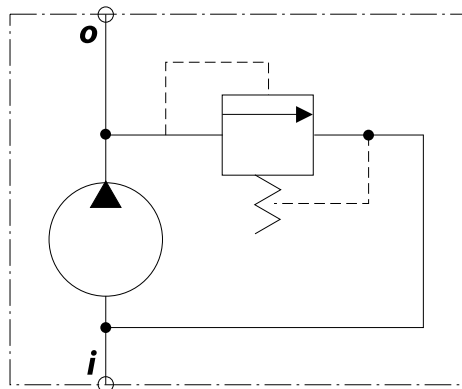

**Dimensions**

**SNP1NN - 01BA and 01DA**

This drawing shows the standard porting for 01BA and 01DA. Available in Series SNP1NN only.

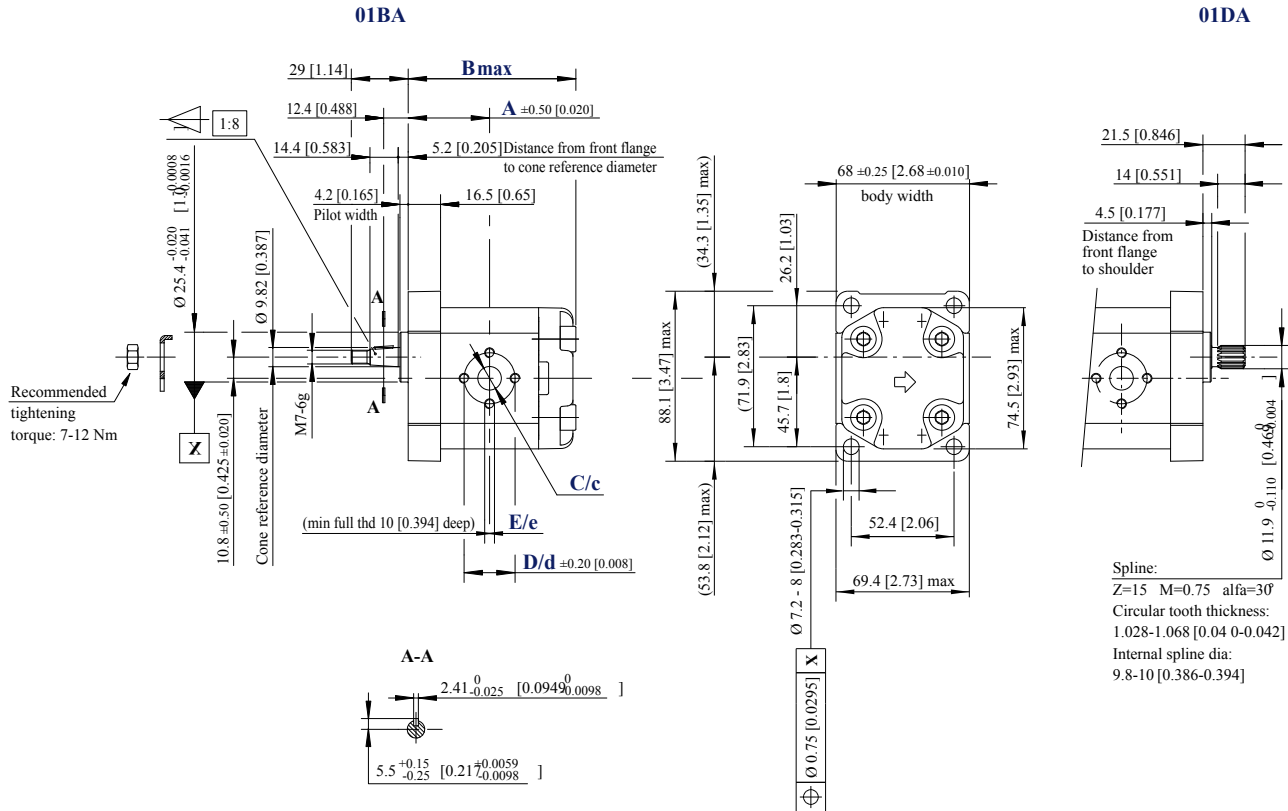

SNP1NN – 01BA and 01DA dimensions

Frame size		1,2	1,7	2,2	2,6	3,2	3,8	4,3	6,0	7,8
Dimension	A	37.75 [1.486]	38.5 [1.516]	39.5 [1.555]	40.5 [1.634]	41.5 [1.634]	42.5 [1.673]	43.5 [1.713]	46.75 [1.841]	50.0 [1.969]
	B	79.5 [3.130]	81.0 [3.189]	83.0 [3.268]	85.0 [3.346]	87.0 [3.425]	89.0 [3.504]	91.0 [3.583]	97.5 [3.839]	104.0 [4.094]
Inlet/Outlet	C/c	12 [0.472]								
	D/d	26 [1.024]								
	E/e	M5								

Model code examples and maximum shaft torque

Flange/drive gear	Model code example	Maximum shaft torque
01BA	SNP1NN/3,8RN01BAP1C2C2NNNN/NNNNN	25 N•m [221 lb•in]
01DA	SNP1NN/6,0LN01DAP1C2C2NNNN/NNNNN	35 N•m [310 lb•in]

For further details on ordering, see [Model code](#).

**Dimensions**

**SKP1NN – 02BB and 02FA**

This drawing shows the standard porting for 02BB and 02FA. Available in Series SKP1NN only.

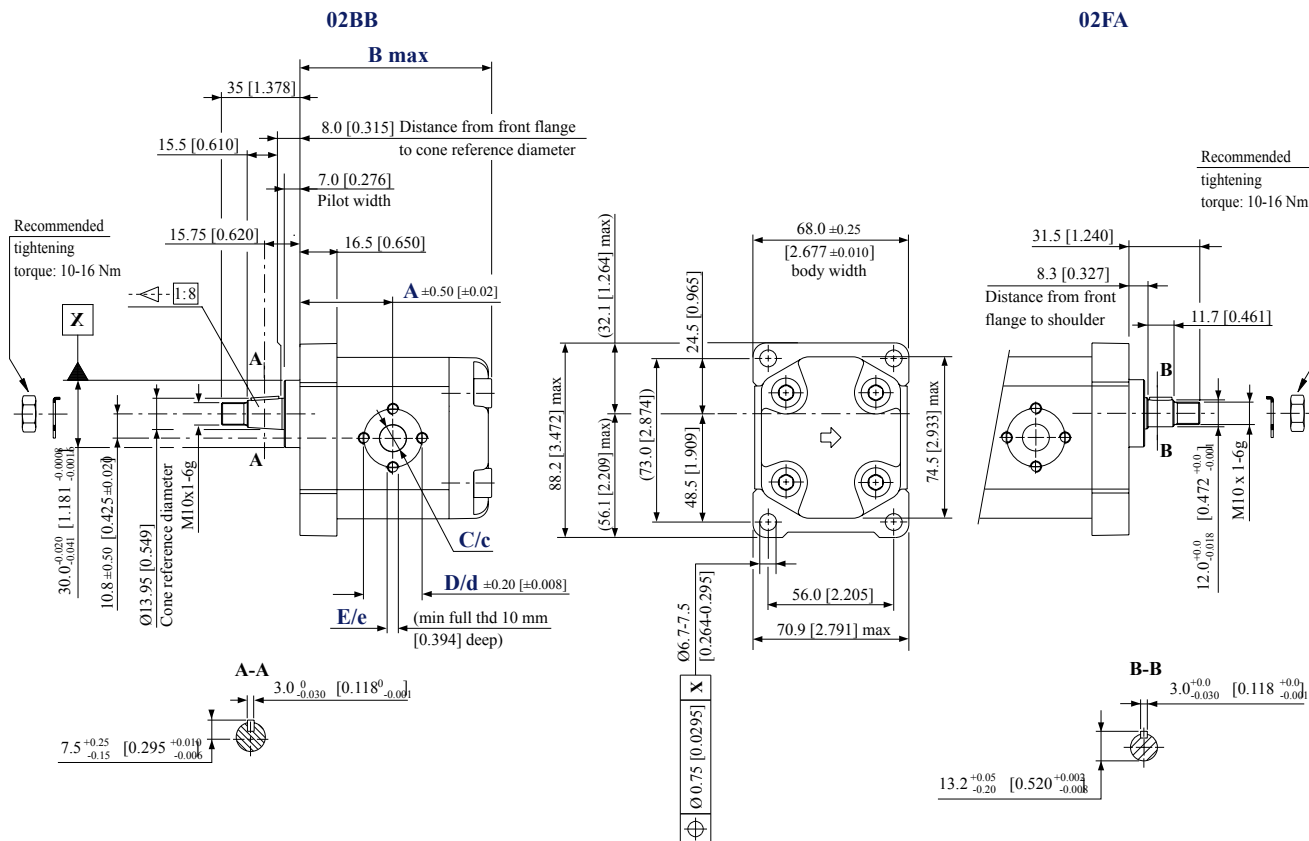

SKP1NN – 02BB and 02FA dimensions

Frame size		1,2	1,7	2,2	2,6	3,2	3,8	4,3	6,0	7,8	010	012
Dimension	A	37.75 [1.486]	38.5 [1.516]	39.5 [1.555]	40.5 [1.634]	41.5 [1.634]	42.5 [1.673]	43.5 [1.713]	46.75 [1.841]	50.0 [1.969]	54.5 [2.146]	58.5 [2.303]
	B	79.5 [3.130]	81.0 [3.189]	83.0 [3.268]	85.0 [3.346]	87.0 [3.425]	89.0 [3.504]	91.0 [3.583]	97.5 [3.839]	104.0 [4.094]	113.0 [4.449]	121.0 [4.764]
Inlet/Outlet	C/c	12 [0.472]										
	D/d	26 [1.024]										
	E/e	M5										

Model code examples and maximum shaft torque

Flange/drive gear	Model code example	Maximum shaft torque
02BB	SKP1NN/6,0RNO2BBP1C2C2NNNN/NNNNN	50 N·m [442 lb·in]
02FA	SKP1NN/2,2LN02FAP1C2C2NNNN/NNNNN	24 N·m [212 lb·in]

For further details on ordering, see [Model code](#).

**Dimensions**

**SNP1NN – 03CA**

This drawing shows the standard porting for 03CA.

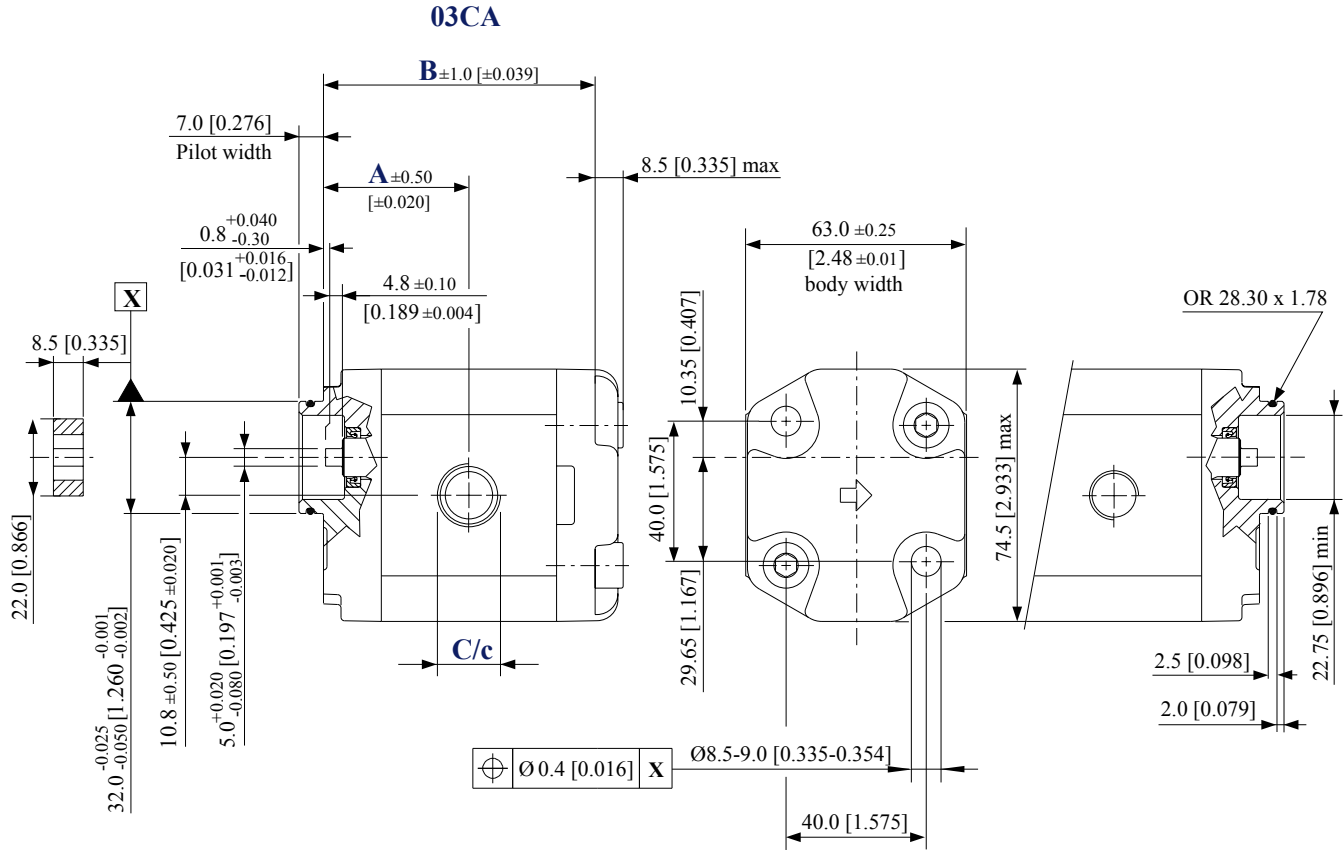

SNP1NN – 03CA dimensions

Frame size	1,2	1,7	2,2	2,6	3,2	3,8	4,3	6,0	7,8	
Dimension	A	37.75 [1.486]	38.5 [1.516]	39.5 [1.555]	40.5 [1.634]	41.5 [1.634]	42.5 [1.673]	43.5 [1.713]	46.75 [1.841]	50 [1.969]
	B	70 [2.756]	71.5 [2.815]	73.5 [2.894]	75.5 [2.972]	77.5 [3.051]	79.5 [3.130]	81.5 [3.209]	88.0 [3.465]	94.5 [3.720]
Inlet	C	M18 x 1.5 THD 12 [0.472] deep								
Outlet	c	M14 x 1.5, THD 12 [0.472] deep				M18 x 1.5, THD 12 [0.472] deep				

Model code examples and maximum shaft torque

Flange/drive gear	Model code example	Maximum shaft torque
03CA	SNP1NN/1,7RN03CA03D5D3NNNN/NNNN	14 N·m [124 lb·in]

For further details ordering, see [Model code](#).

**Dimensions**
**SKP1NN – 06GA and 06SA**

This drawing shows the standard porting for 06GA and 06SA. Available in Series SKP1NN only.

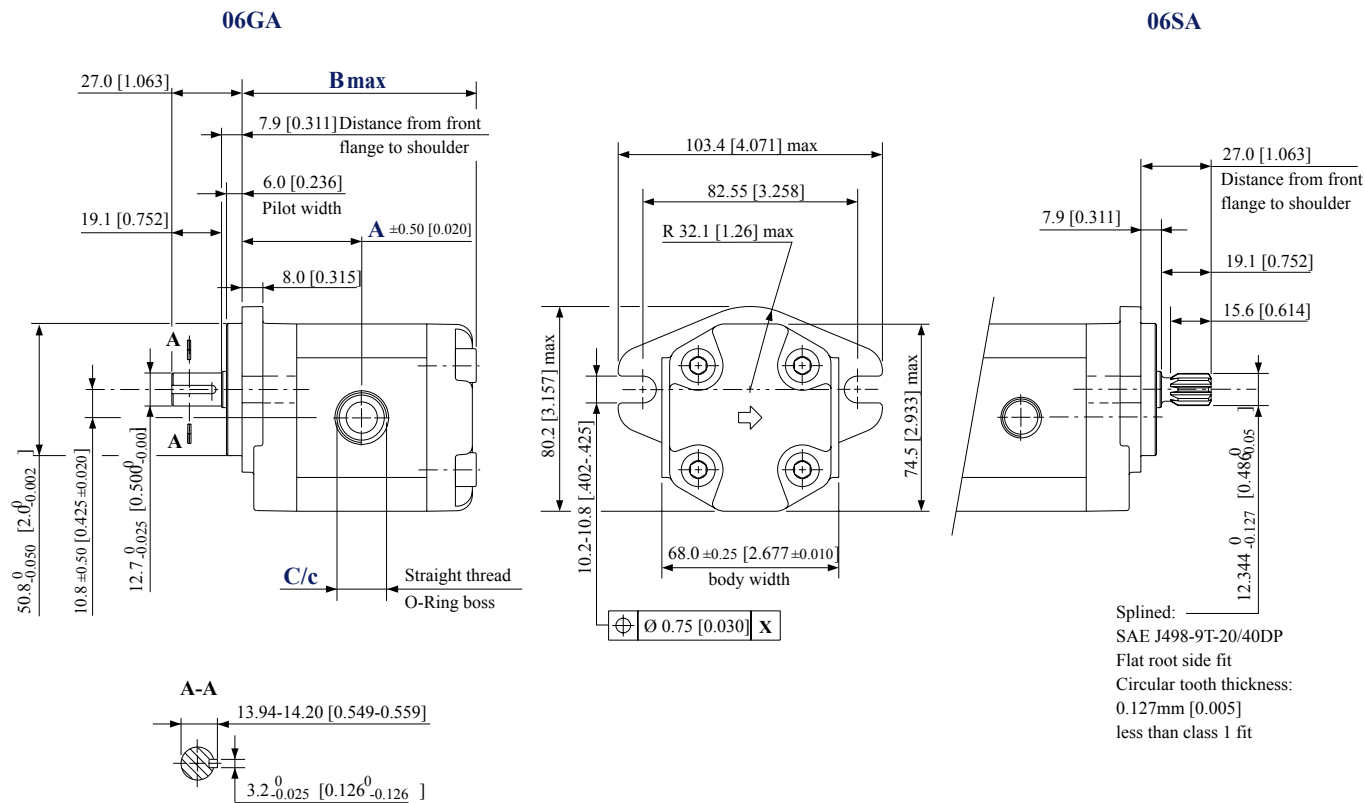

SKP1NN – 06GA and 06SA dimensions

Frame size	1,2	1,7	2,2	2,6	3,2	3,8	4,3	6,0	7,8	010	012	
<b>Dimension</b>	<b>A</b>	42.25 [1.663]	43 [1.693]	44 [1.732]	45.0 [1.772]	46.0 [1.811]	47 [1.850]	48 [1.890]	51.25 [2.018]	54.5 [2.146]	59 [2.323]	63.5 [2.50]
	<b>B</b>	84 [3.307]	85.5 [3.366]	87.5 [3.445]	89.5 [3.524]	91.5 [3.602]	93.5 [3.681]	95.5 [3.760]	102 [4.016]	108.5 [4.272]	117.5 [4.626]	125.5 [4.941]
<b>Inlet</b>	<b>C</b>	¾-16UNF-2B, THD 14.3 [0.563] deep										
<b>Outlet</b>	<b>c</b>	9/16-18UNF-2B, THD 12.7 [0.500] deep										

Flange/drive gear	Model code example	Maximum shaft torque
<b>06GA</b>	SKP1NN/3,2RN06GAP1E4E3NNNN/NNNNN	32 N·m [283 lb·in]
<b>06SA</b>	SKP1NN/012LN06SAP1E4E3NNNN/NNNNN	34 N·m [301 lb·in]

 For further details on ordering, see [Model code](#).



Shandong Topkit Construction Machinery Equipment Co., Ltd., is a high-tech company specialized in the manufacturing and supplying for hydraulic pumps, valves, motors, reducers, gearboxes, etc.

We mainly focuses on hydraulic parts for hydraulic excavators, and the products have been serialized. We dedicated on the following three systems and five series products. We specialized in Positive flow system, negative flow system, load sensing control system;

Five series refer to 6-ton products, 8-ton products, 20-ton products, 40-ton products, concrete series products.

Our featured products 20-ton excavator negative flow pump, positive flow pump, positive flow valve, and rotary motor passed the national appraisal in 2012.

In quality control, we passed the ISO2001:2015 quality management system certification in 2022 ; and we also passed the ISO14001:2015 environmental management system certification in this year. We always persist in the quality control and try best to enhance quality all the time.

In R&D Field, we have a professional team with more than 10 people, of which more than 90% have accumulated more than ten years of hydraulic product technology, and have become the main force for the company to develop new products.

Now our products has exported to dozens of countries, such as Russia, Middle East countries, Asian and African countries.

We will continue to develop new products in top quality, and sincerely wish establishing business cooperation with more friends. Thanks

## Contact Us

phone:+86 150 539 47199

whatsapp:+86 150 539 47199

email:george@topkitparts.com